

SLIDING DOORS with ALU CLAD

**NORWOOD SP.ZO.O.**

Ul. Rataja 6, Rusocin  
83-031 Łęgowo  
+48 692 22 00  
biuro@norwood.pl

Description **SDA N95 SLIDING DOORS**  
**HEAD SECTION - fixed part (24 mm glass)**

Revis.	Date	Size	1:1	Drw.	Date	02.01.2018
Verif.	Date	Drawing no. SDA - 24 - he - f - 01				

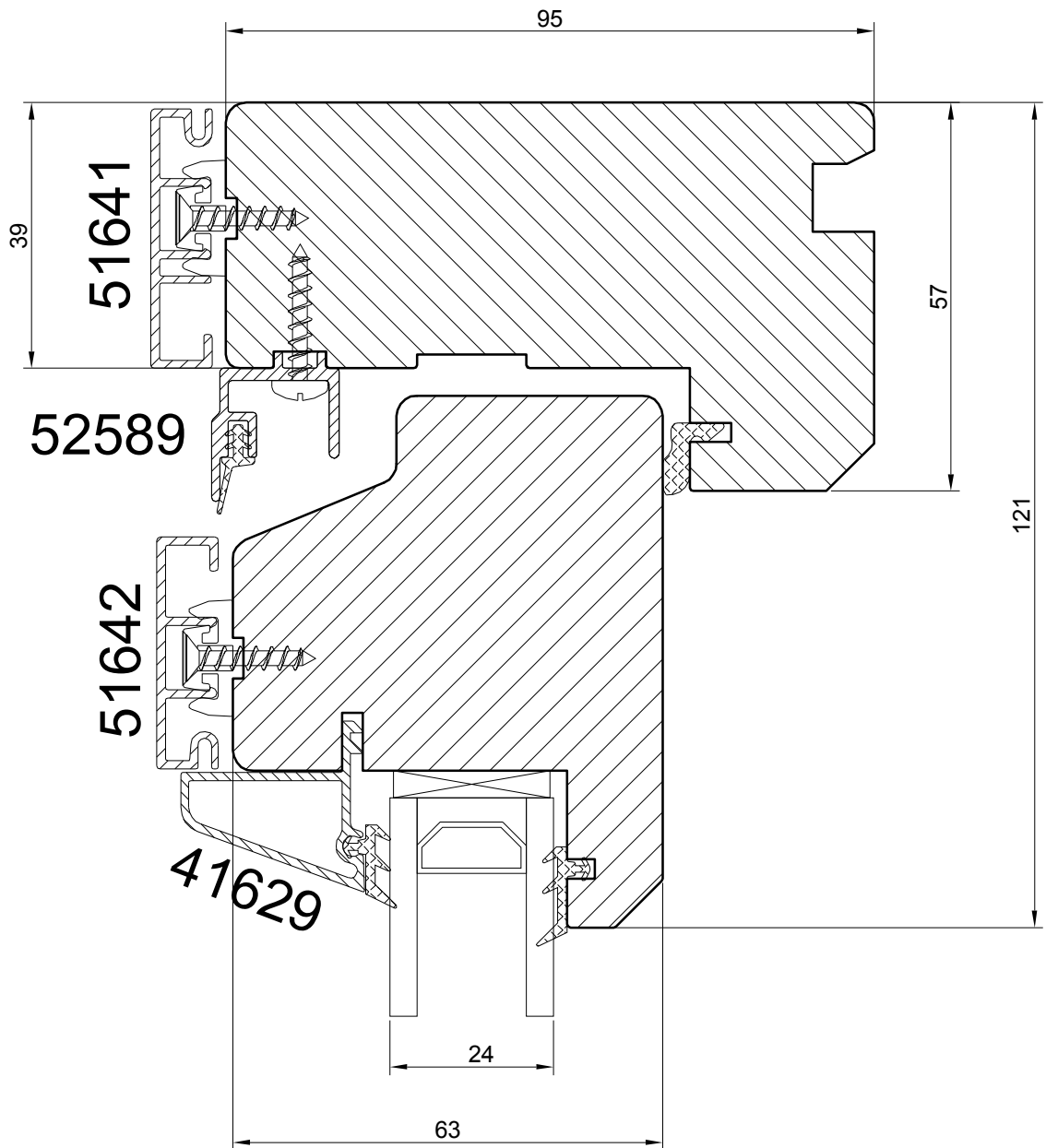

SLIDING DOORS with ALU CLAD

**NORWOOD SP.ZO.O.**

Ul. Rataja 6, Rusocin  
83-031 Łęgowo  
+48 692 22 00  
biuro@norwood.pl

<i>Description</i>		<b>SDA N95 SLIDING DOORS</b>			
		<b>HEAD SECTION - sliding part (24 mm glass)</b>			
<i>Revis.</i>	<i>Date</i>	<i>Size</i>	<i>Drw.</i>	<i>Date</i>	
		<b>1:1</b>		<b>02.01.2018</b>	
<i>Verif.</i>	<i>Date</i>	<i>Drawing no.</i>			
		<b>SDA - 24 - he - s - 01</b>			

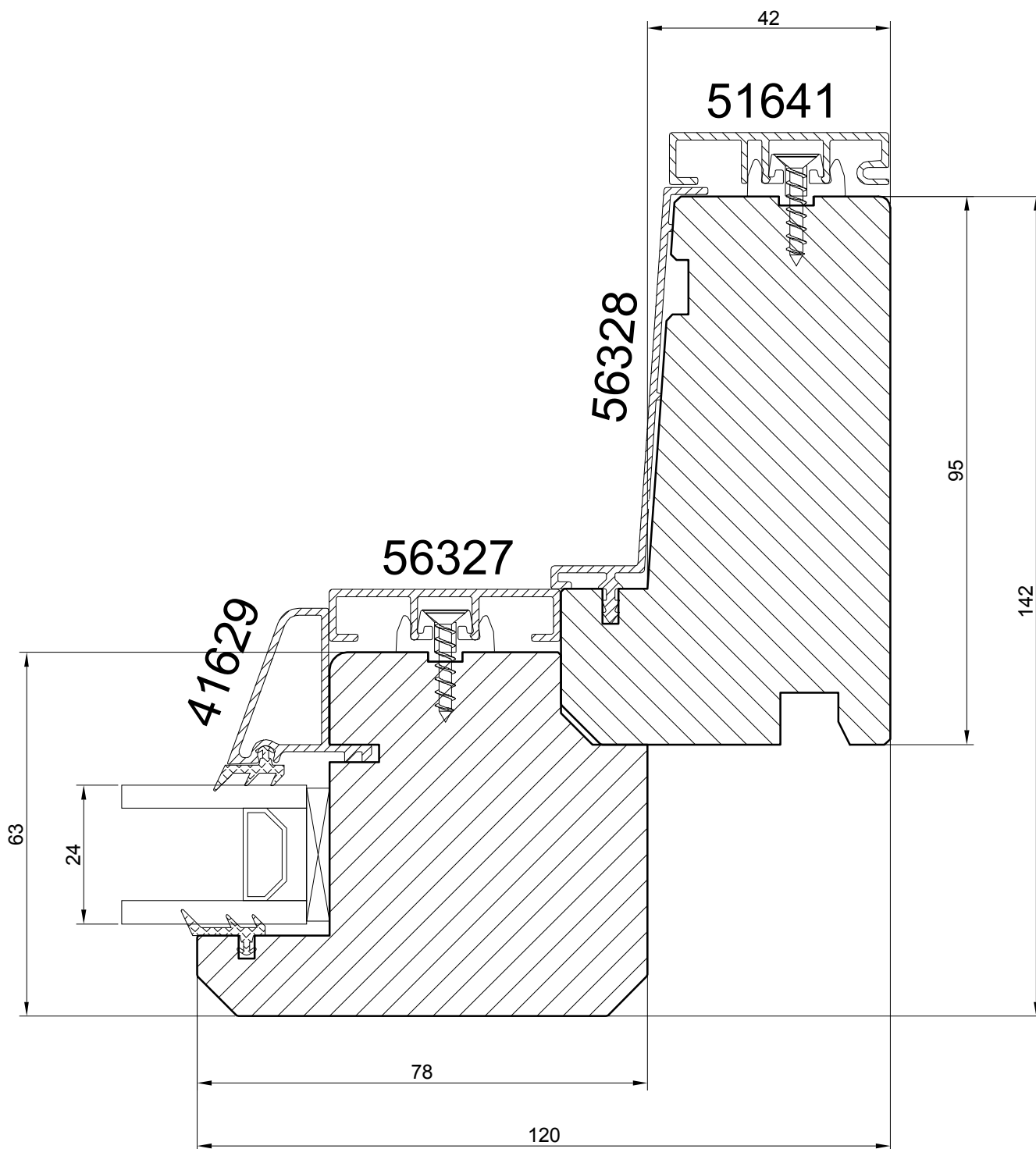

SLIDING DOORS with ALU CLAD

**NORWOOD SP.ZO.O.**

Ul. Rataja 6, Rusocin  
83-031 Łęgowo  
+48 692 22 00  
biuro@norwood.pl

Description **SDA N95 SLIDING DOORS**  
**JAMB SECTION - fixed part (24 mm glass)**

Revis.	Date	Size	1:1	Drw.	Date	02.01.2018
Verif.	Date	Drawing no. SDA - 24 - se - f - 01				

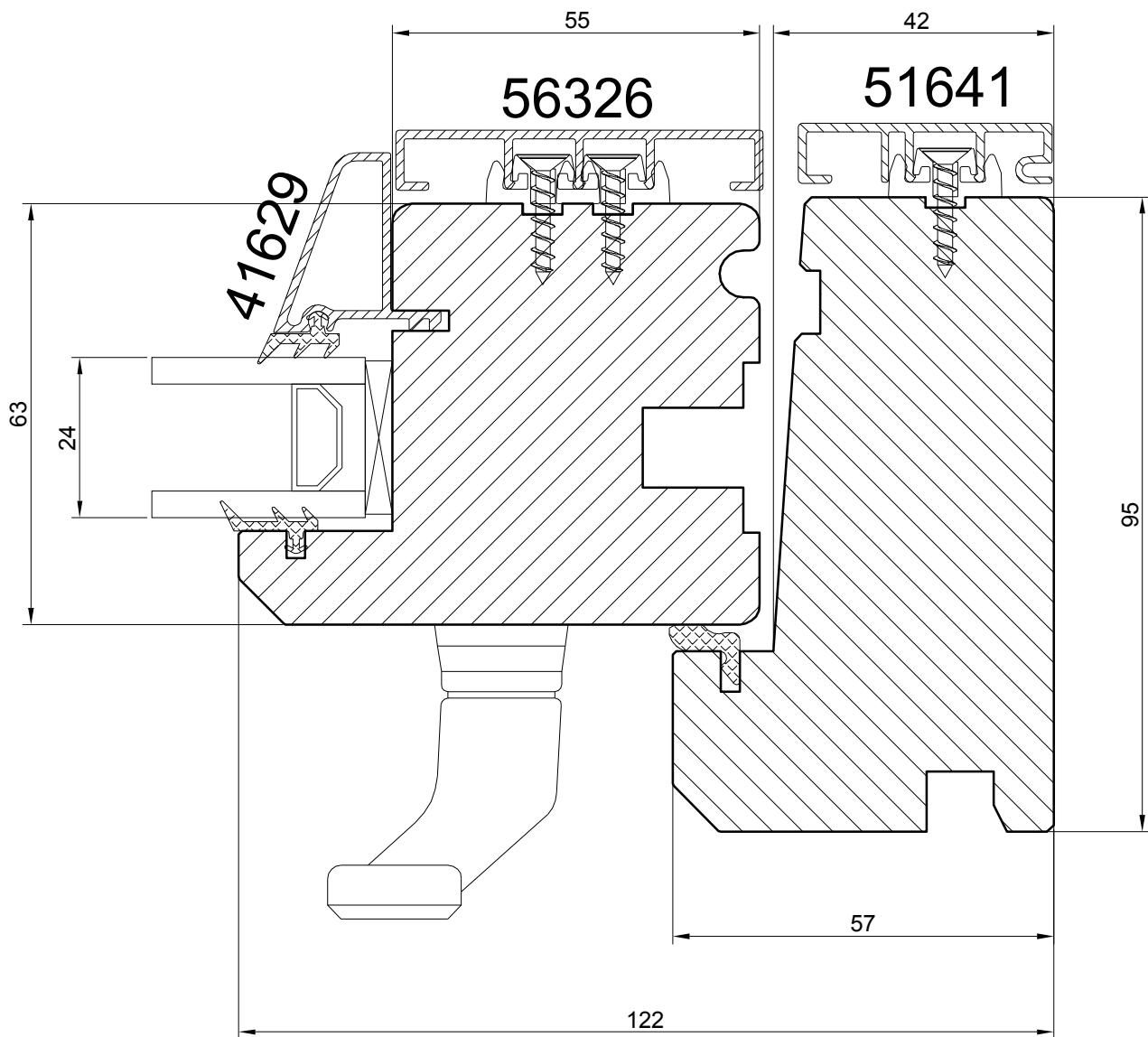

SLIDING DOORS with ALU CLAD

**NORWOOD SP.ZO.O.**

Ul. Rataja 6, Rusocin  
83-031 Łęgowo  
+48 692 22 00  
biuro@norwood.pl

<i>Description</i>		<b>SDA N95 SLIDING DOORS</b>			
		<b>JAMB SECTION - sliding part (24 mm glass)</b>			
<i>Revis.</i>	<i>Date</i>	<i>Size</i>	<i>Drw.</i>	<i>Date</i>	
		1:1		02.01.2018	
<i>Verif.</i>	<i>Date</i>	<i>Drawing no.</i>			
		SDA - 24 - se - s - 01			

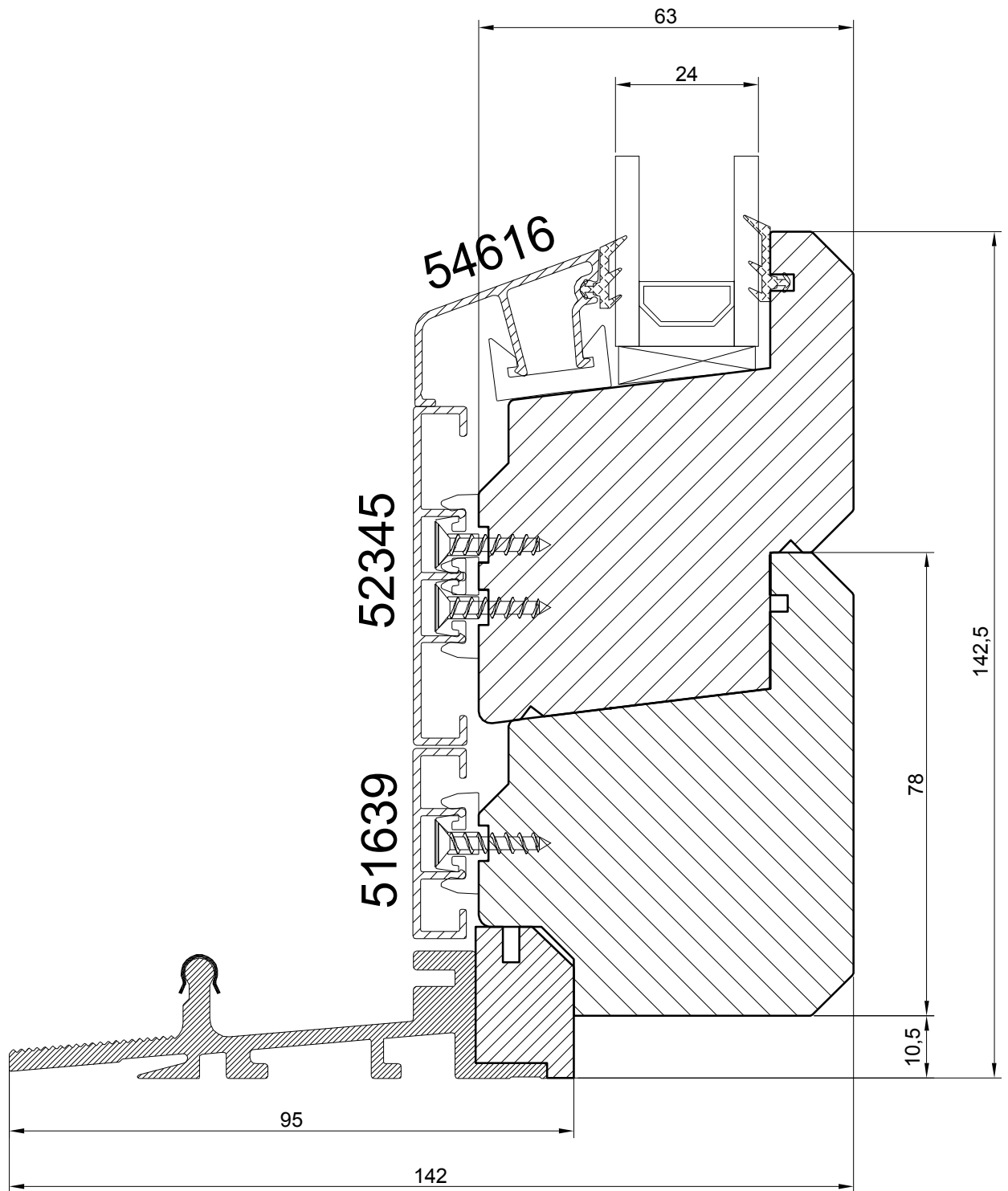

SLIDING DOORS with ALU CLAD

**NORWOOD SP.ZO.O.**

Ul. Rataja 6, Rusocin  
83-031 Łęgowo  
+48 692 22 00  
biuro@norwood.pl

<i>Description</i>		<b>SDA N95 SLIDING DOORS</b>			
		<b>LOW ALU THRESHOLD - fixed part (24 mm glass)</b>			
<i>Revis.</i>	<i>Date</i>	<i>Size</i>	<i>Drw.</i>	<i>Date</i>	
		<b>1:1</b>		<b>02.01.2018</b>	
<i>Verif.</i>	<i>Date</i>	<i>Drawing no.</i>			
		<b>SDA - 24 - tdl - f - 01</b>			

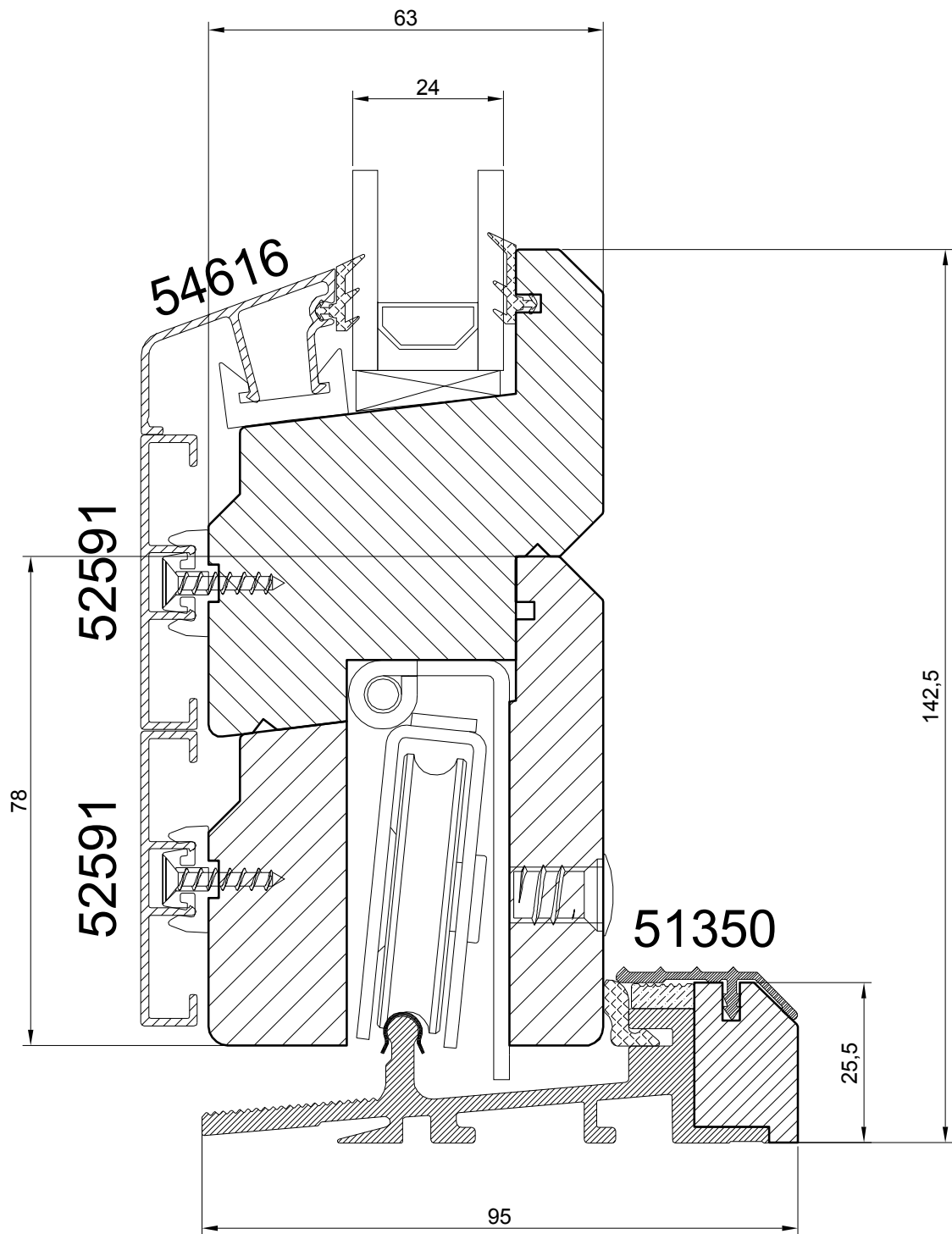

SLIDING DOORS with ALU CLAD

**NORWOOD SP.ZO.O.**

Ul. Rataja 6, Rusocin  
83-031 Łęgowo  
+48 692 22 00  
biuro@norwood.pl

<i>Description</i>		<b>SDA N95 SLIDING DOORS</b>			
		<b>LOW ALU THRESHOLD - sliding part (24 mm glass)</b>			
<i>Revis.</i>	<i>Date</i>	<i>Size</i>	<i>Drw.</i>	<i>Date</i>	
		<b>1:1</b>		<b>02.01.2018</b>	
<i>Verif.</i>	<i>Date</i>	<i>Drawing no.</i>			
		<b>SDA - 24 - tdl - s - 01</b>			

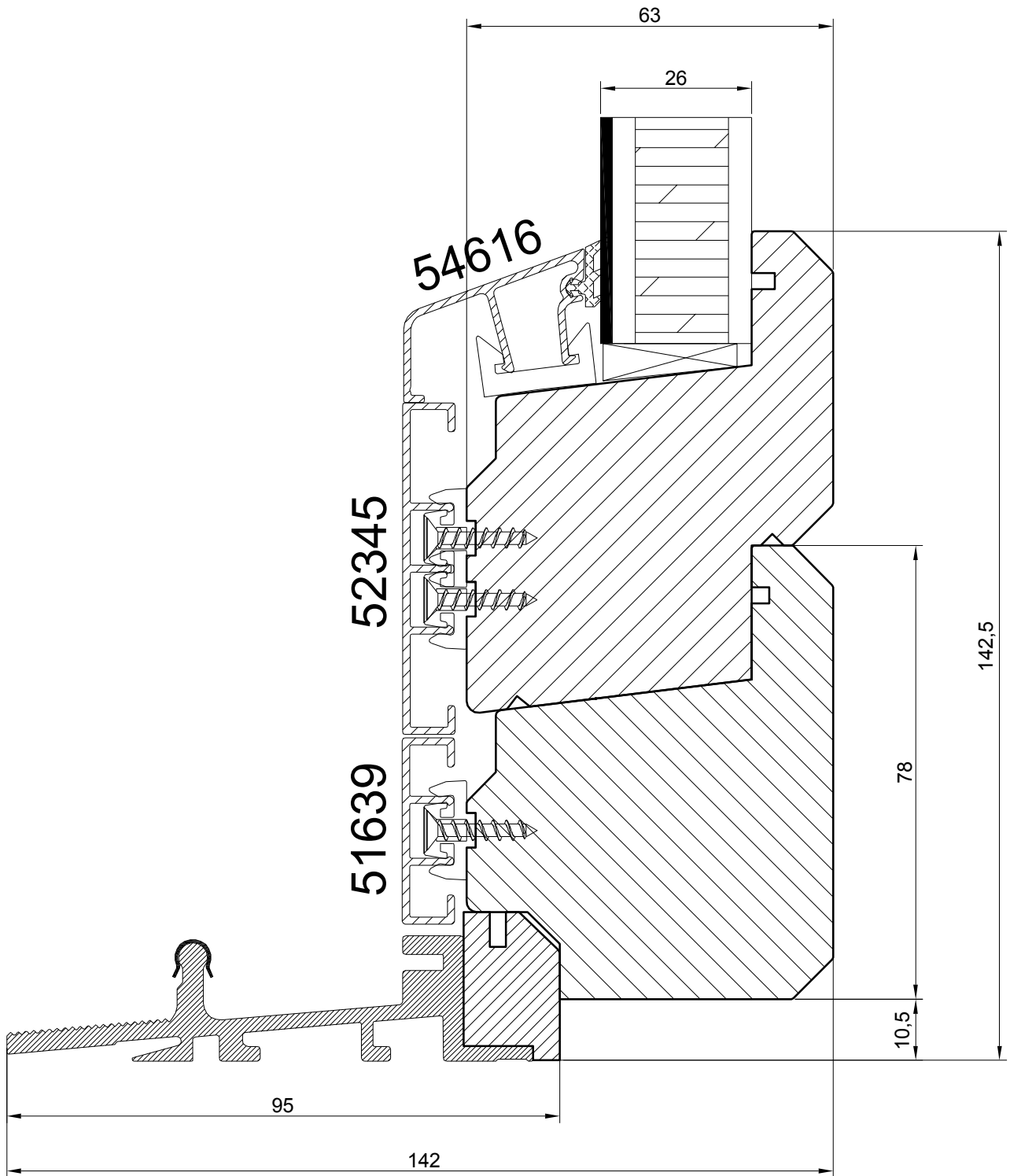

SLIDING DOORS with ALU CLAD

**NORWOOD SP.ZO.O.**

Ul. Rataja 6, Rusocin  
83-031 Łęgowo  
+48 692 22 00  
biuro@norwood.pl

<i>Description</i>		<b>SDA N95 SLIDING DOORS</b>			
		<b>LOW ALU THRESHOLD - fixed part (26 mm panel)</b>			
<i>Revis.</i>	<i>Date</i>	<i>Size</i>	<i>Drw.</i>	<i>Date</i>	
		<b>1:1</b>		<b>02.01.2018</b>	
<i>Verif.</i>	<i>Date</i>	<i>Drawing no.</i>			
		<b>SDA - 26p - tdl - f - 01</b>			

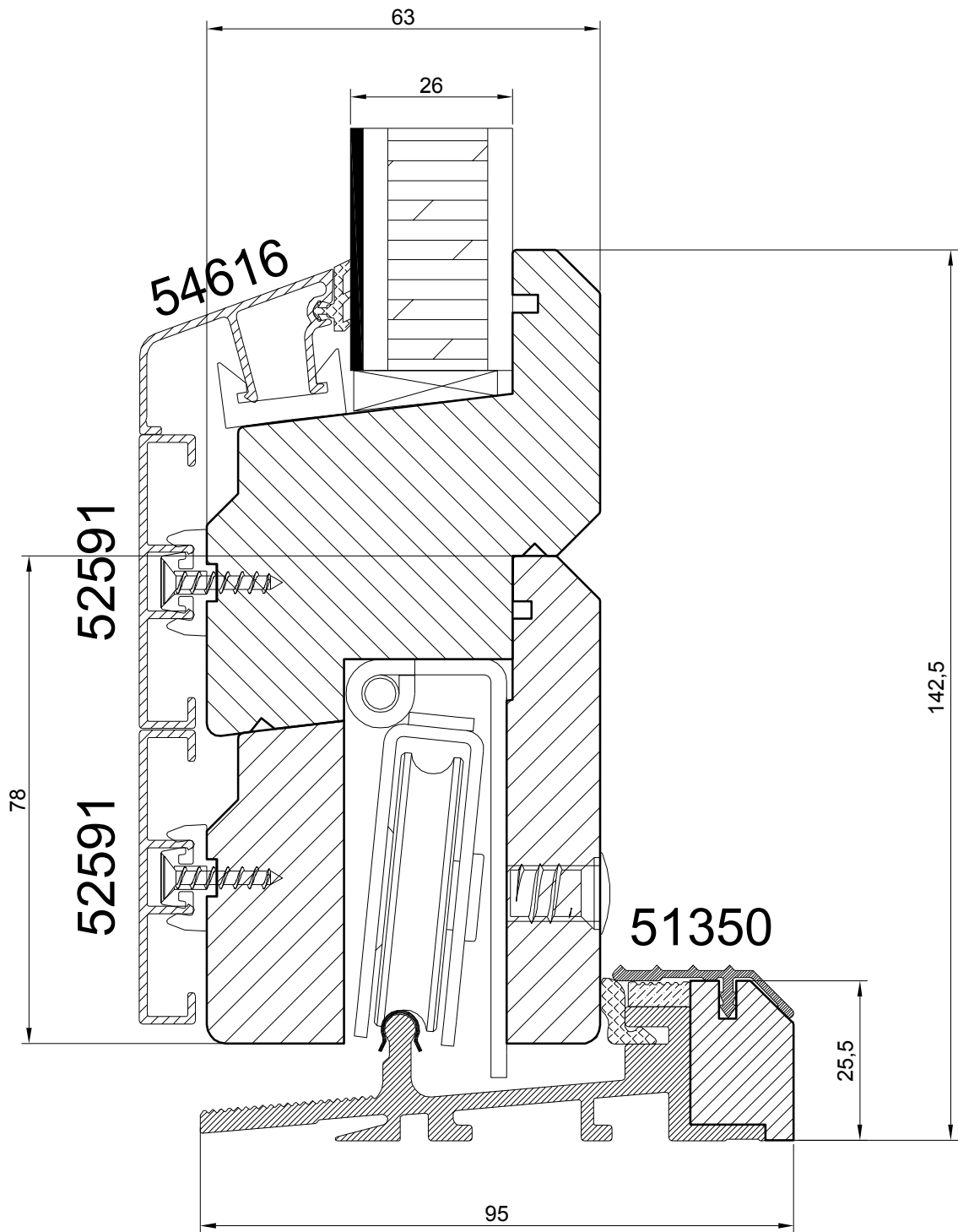

**SLIDING DOORS with ALU CLAD**

**NORWOOD SP.ZO.O.**

Ul. Rataja 6, Rusocin  
 83-031 Łęgowo  
 +48 692 22 00  
 biuro@norwood.pl

<i>Description</i>		<b>SDA N95 SLIDING DOORS</b>			
		<b>LOW ALU THRESHOLD - sliding part (26 mm panel)</b>			
<i>Revis.</i>	<i>Date</i>	<i>Size</i>	<i>Drw.</i>	<i>Date</i>	
		<b>1:1</b>		<b>02.01.2018</b>	
<i>Verif.</i>	<i>Date</i>	<i>Drawing no.</i>			
		<b>SDA - 26p - tdl - s - 01</b>			



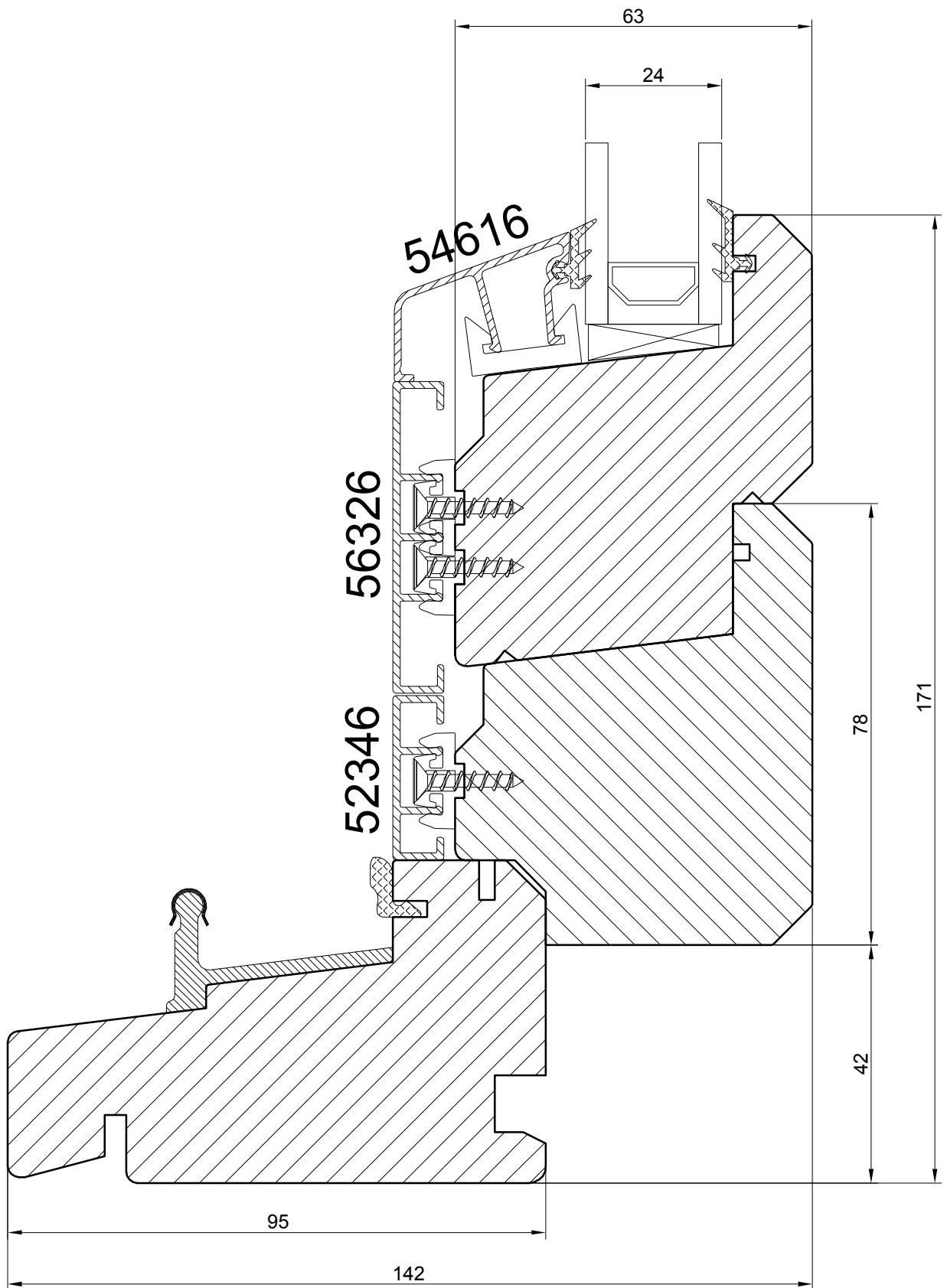

SLIDING DOORS with ALU CLAD

**NORWOOD SP.ZO.O.**

Ul. Rataja 6, Rusocin  
 83-031 Łęgowo  
 +48 692 22 00  
 biuro@norwood.pl

Description **SDA N95 SLIDING DOORS**  
**HIGH THRESHOLD - fixed part (24 mm glass)**

Revis.	Date	Size	1:1	Drw.	Date	02.01.2018
Verif.	Date	Drawing no.				SDA - 24 - tdh - f - 01

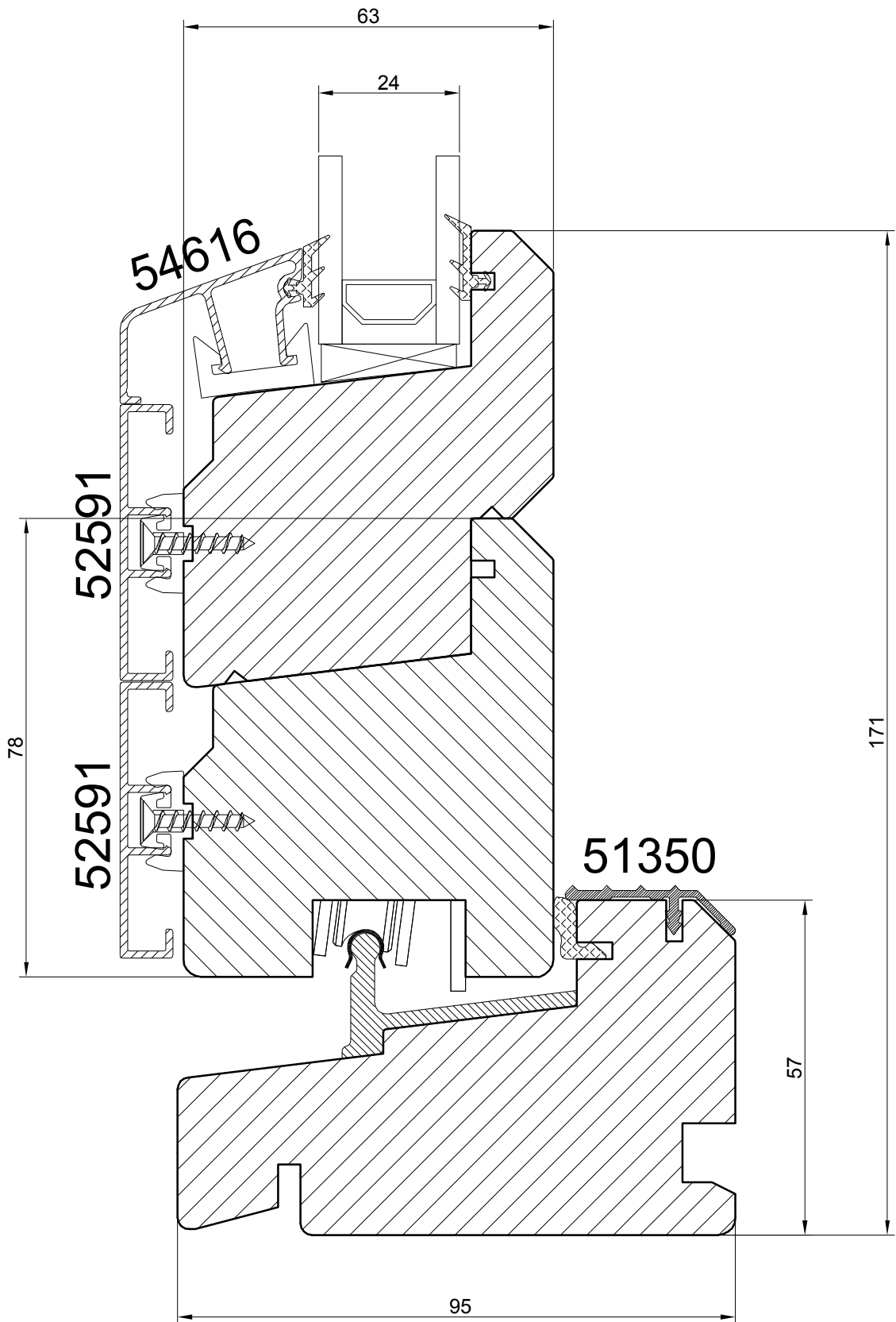

SLIDING DOORS with ALU CLAD

**NORWOOD SP.ZO.O.**

Ul. Rataja 6, Rusocin  
83-031 Łęgowo  
+48 692 22 00  
biuro@norwood.pl

Description **SDA N95 SLIDING DOORS**  
**HIGH THRESHOLD - sliding part (24 mm glass)**

Revis.	Date	Size	1:1	Drw.	Date	02.01.2018
Verif.	Date	Drawing no.		SDA - 24 - tdh - s - 01		

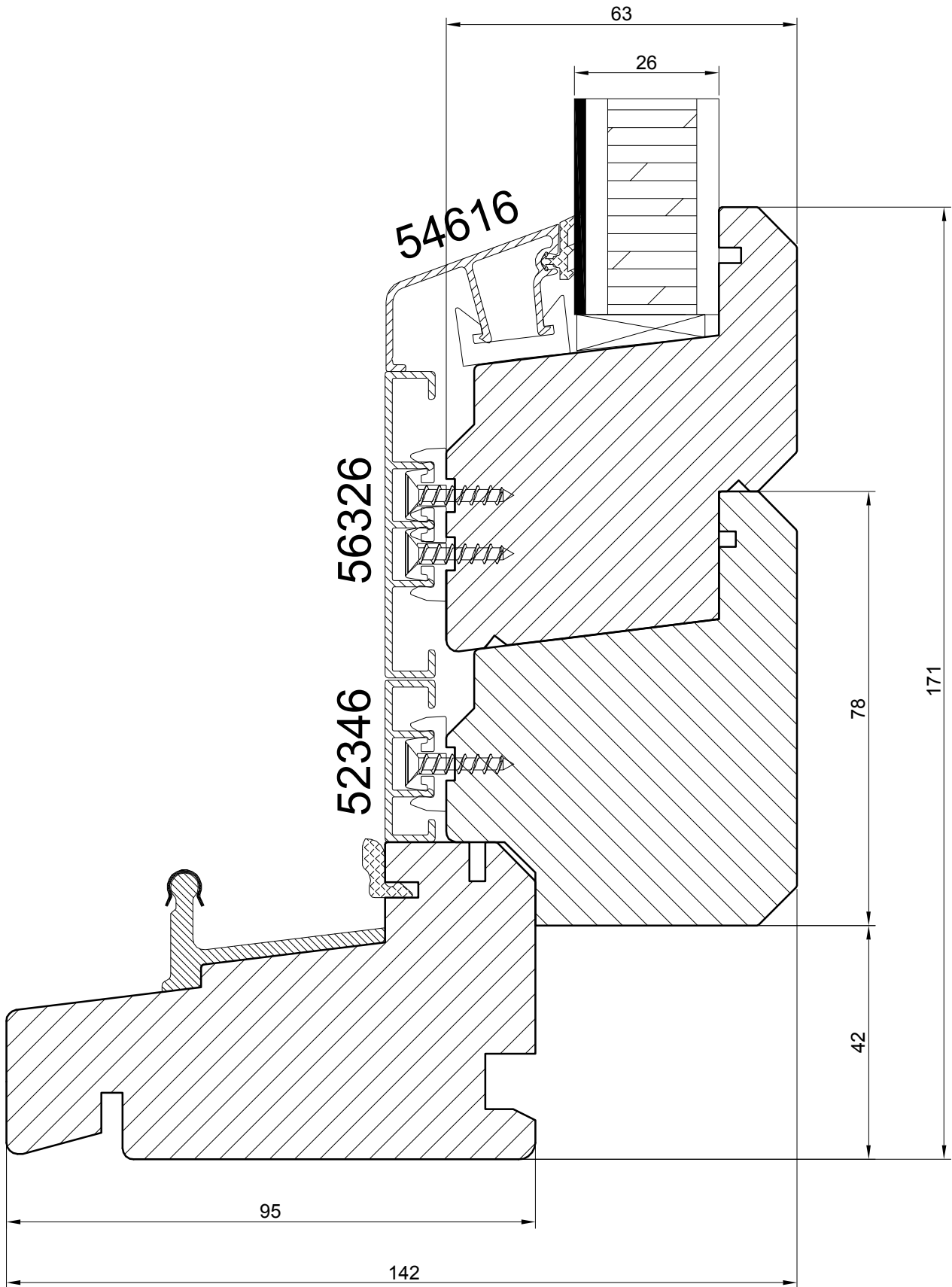

SLIDING DOORS with ALU CLAD

**NORWOOD SP.ZO.O.**

Ul. Rataja 6, Rusocin  
83-031 Łęgowo  
+48 692 22 00  
biuro@norwood.pl

Description **SDA N95 SLIDING DOORS**  
**HIGH THRESHOLD - fixed part (26 mm panel)**

Revis.	Date	Size	1:1	Drw.	Date	02.01.2018
Verif.	Date	Drawing no. <b>SDA - 26p - tdh - f - 01</b>				

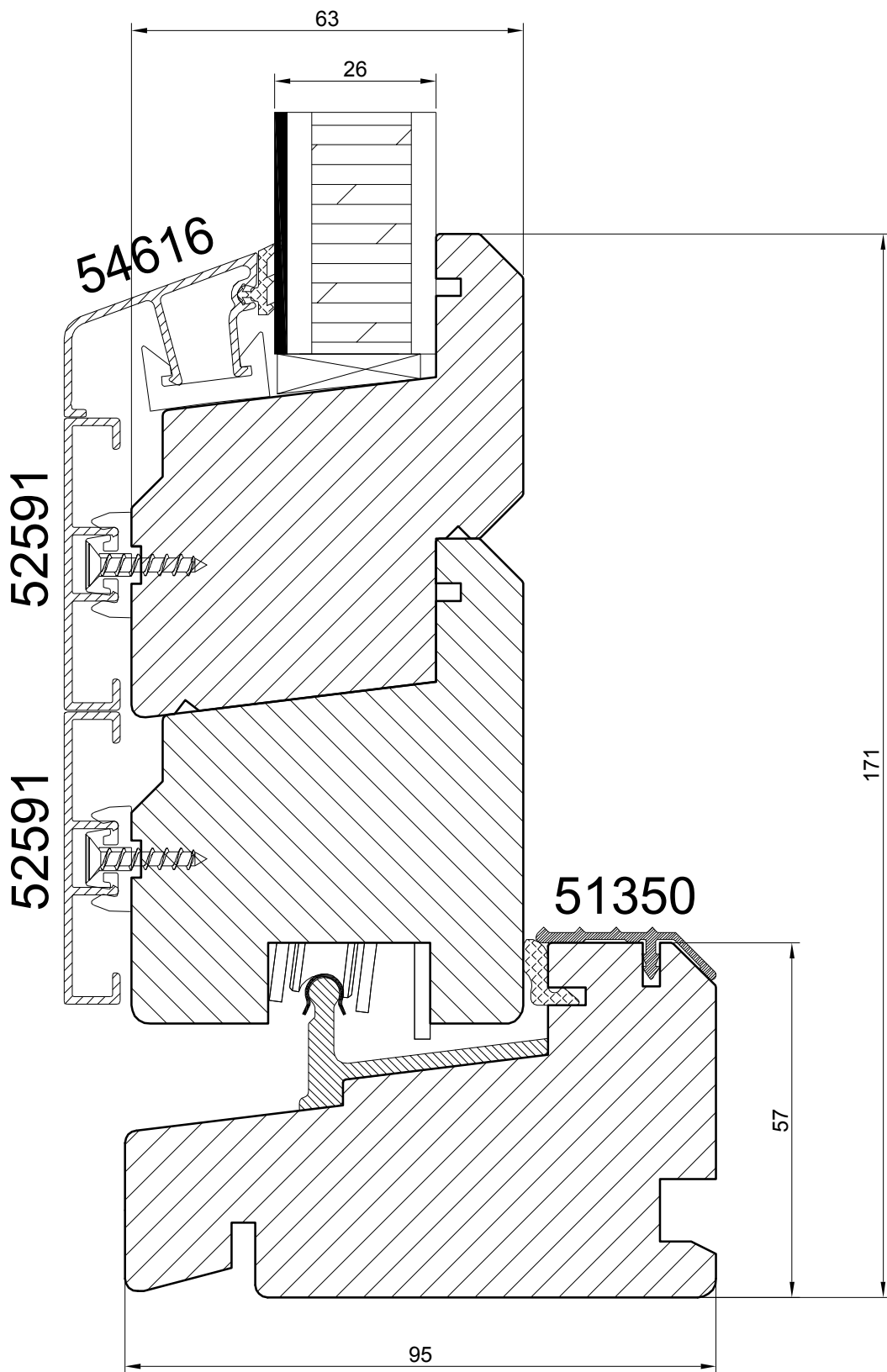

SLIDING DOORS with ALU CLAD

**NORWOOD SP.ZO.O.**

Ul. Rataja 6, Rusocin  
83-031 Łęgowo  
+48 692 22 00  
biuro@norwood.pl

Description **SDA N95 SLIDING DOORS**  
**HIGH THRESHOLD - sliding part (26 mm panel)**

Revis.	Date	Size	1 : 1	Drw.	Date	02.01.2018
Verif.	Date	Drawing no. SDA - 26p - tdh - s - 01				

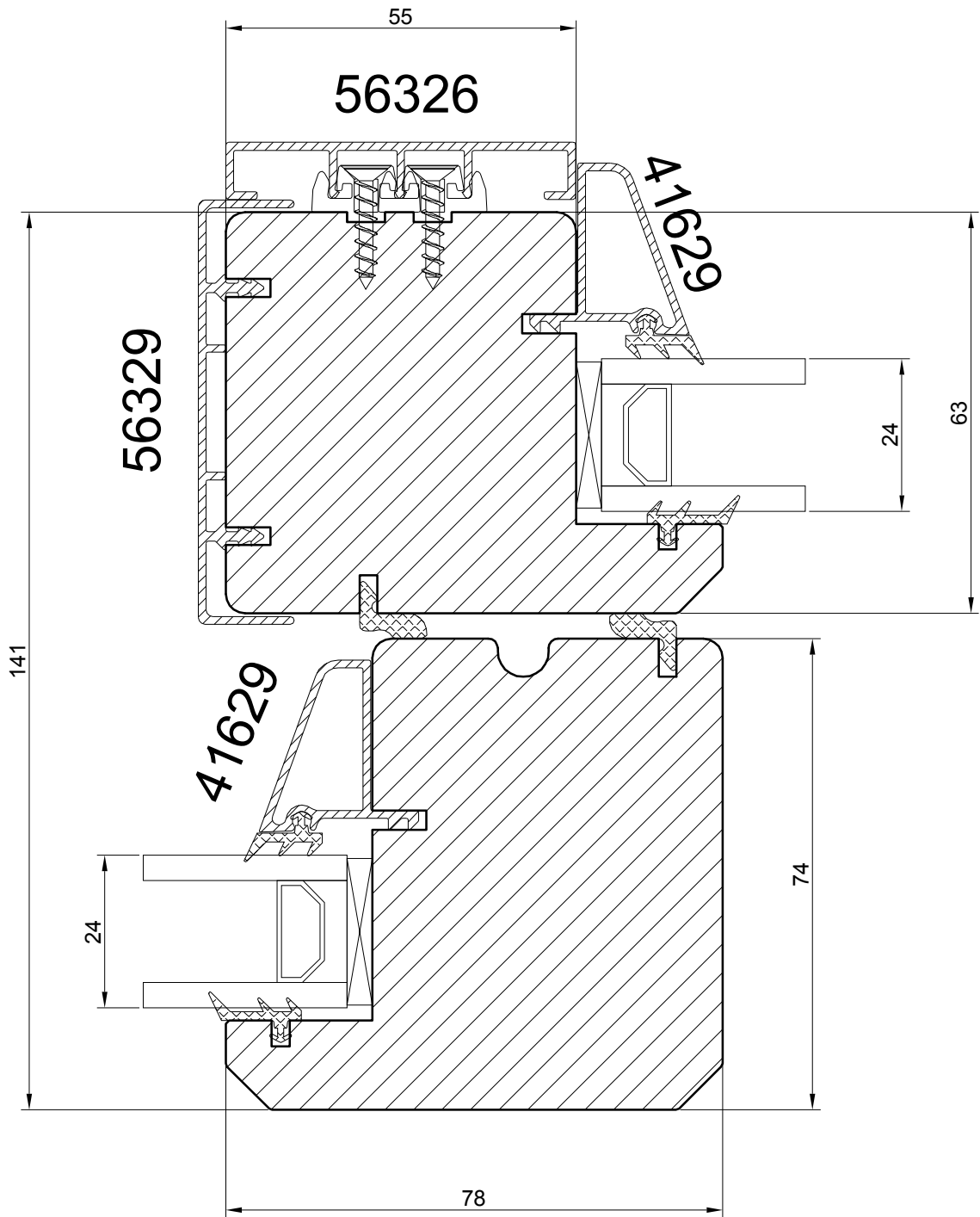

SLIDING DOORS with ALU CLAD

**NORWOOD SP.ZO.O.**

Ul. Rataja 6, Rusocin  
83-031 Łęgowo  
+48 692 22 00  
biuro@norwood.pl

Description **SDA N95 SLIDING DOORS**  
**MIDDLE VIEW (24 mm glass)**

Revis.	Date	Size	1:1	Drw.	Date	02.01.2018
Verif.	Date	Drawing no.	SDA - 24 - md - 01			

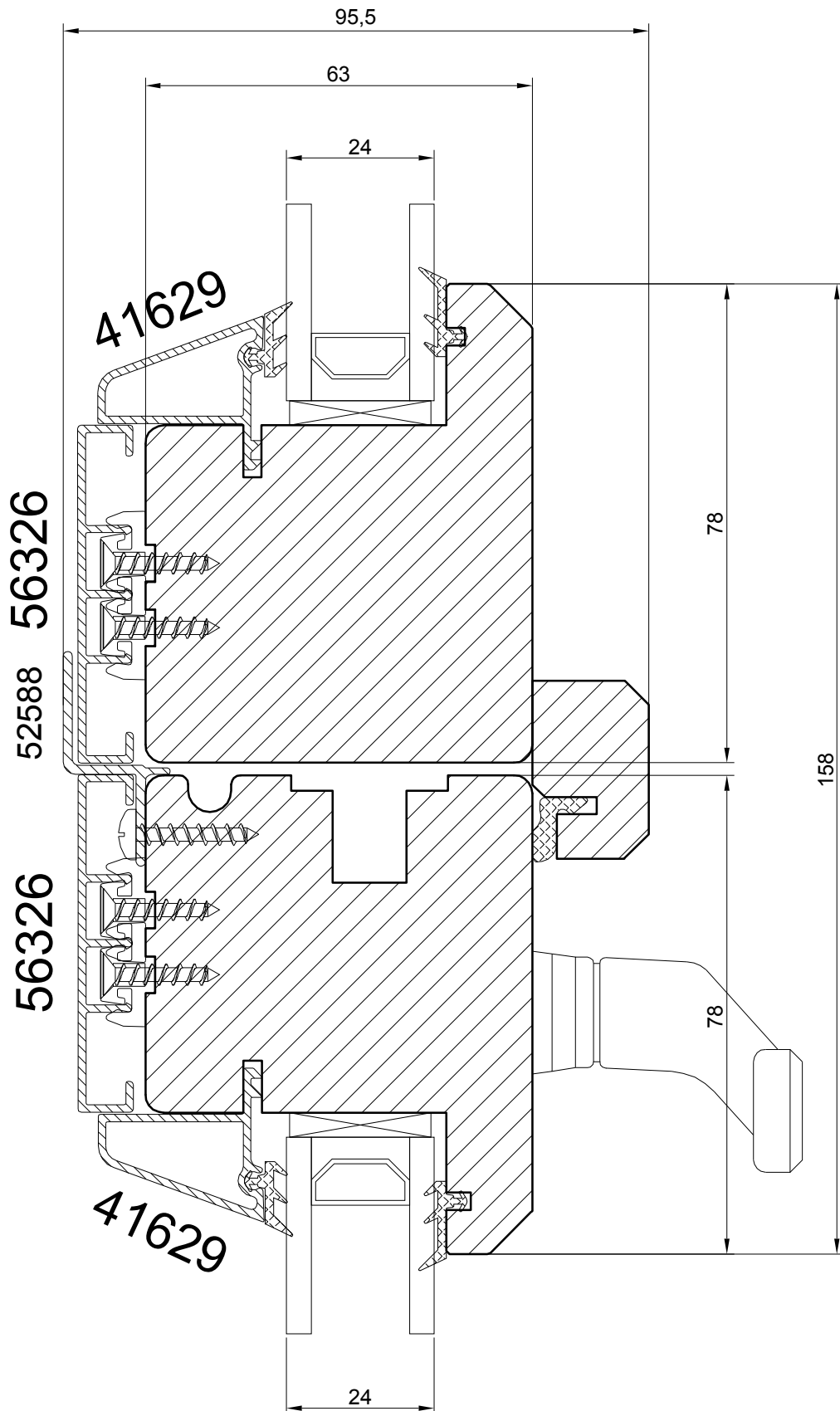

SLIDING DOORS with ALU CLAD

**NORWOOD SP.ZO.O.**

Ul. Rataja 6, Rusocin  
83-031 Łęgowo  
+48 692 22 00  
biuro@norwood.pl

Description **SD N95 SLIDING DOORS**  
**MIDDLE VIEW - SD4 (24 mm glass)**

Revis.	Date	Size	1:1	Drw.	Date	02.01.2018
Verif.	Date	Drawing no.	SD4 - 24 - md - 01			

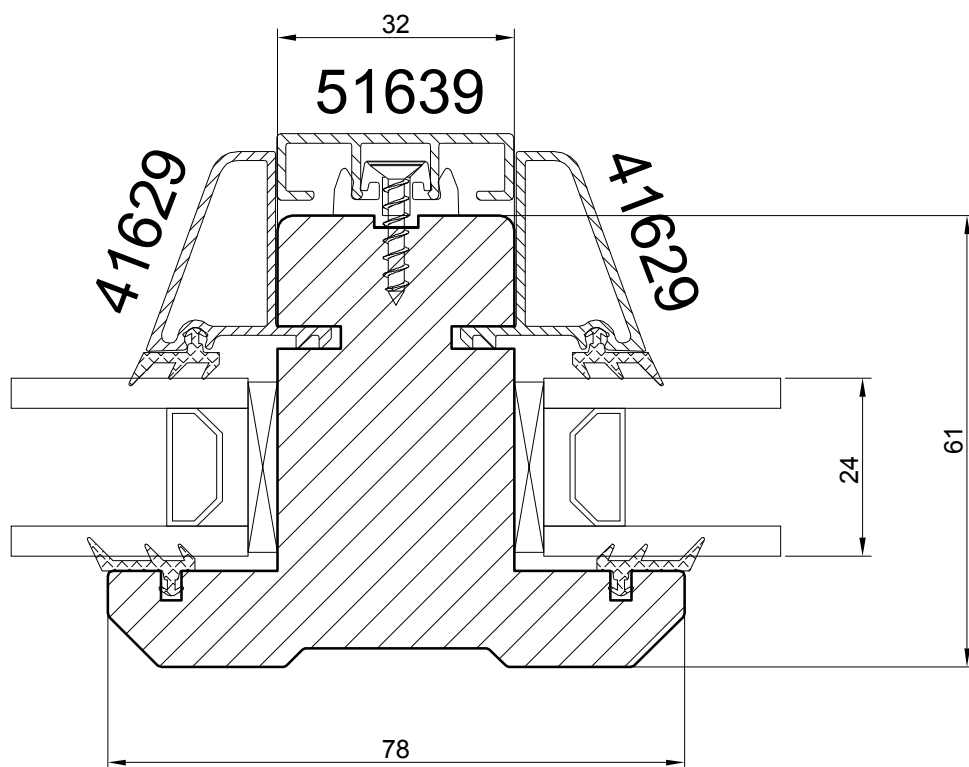

SLIDING DOORS with ALU CLAD

**NORWOOD SP.ZO.O.**

Ul. Rataja 6, Rusocin  
83-031 Łęgowo  
+48 692 22 00  
biuro@norwood.pl

Description **SD N95 SLIDING DOORS**  
**VERTICAL BAR 78 (24 mm glass)**

Revis.	Date	Size	1 : 1	Drw.	Date	02.01.2018
Verif.	Date	Drawing no.	SD - 24 - vs78 - 01			

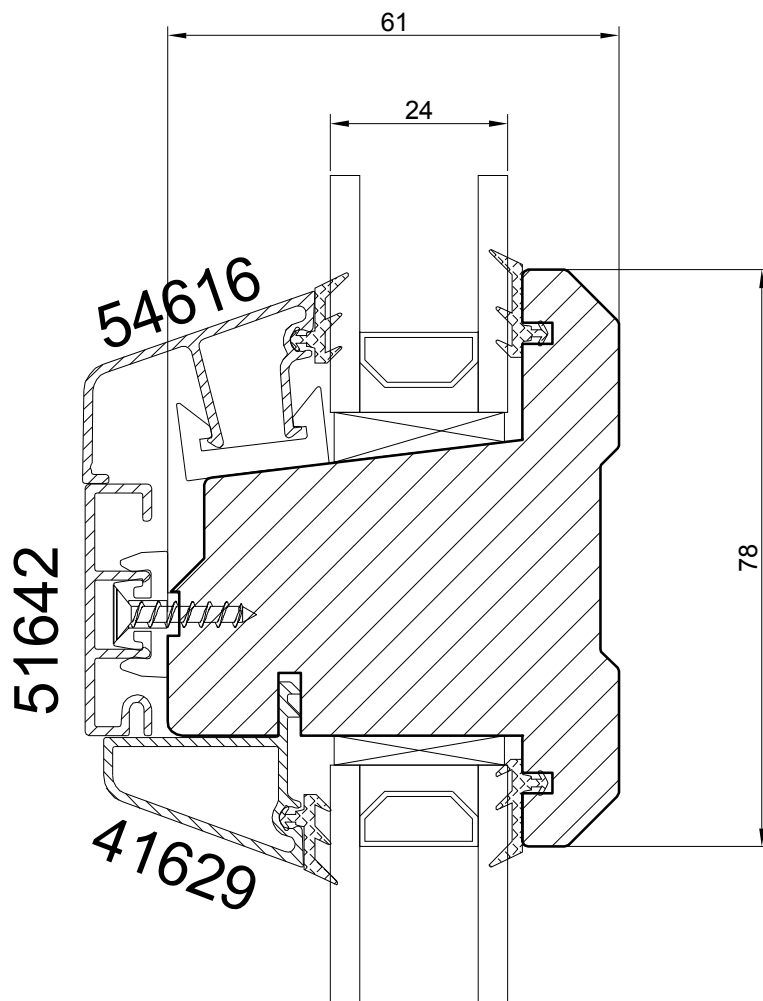

SLIDING DOORS with ALU CLAD

**NORWOOD SP.ZO.O.**

Ul. Rataja 6, Rusocin  
83-031 Łęgowo  
+48 692 22 00  
biuro@norwood.pl

<i>Description</i>		<b>SDA N95 SLIDING DOORS</b>			
		<b>HORIZONTAL BAR 78 (24 mm glass)</b>			
<i>Revis.</i>	<i>Date</i>	<i>Size</i>	<i>Drw.</i>	<i>Date</i>	
		<b>1:1</b>		<b>02.01.2018</b>	
<i>Verif.</i>	<i>Date</i>	<i>Drawing no.</i>			
		<b>SDA - 24 - hs78 - 01</b>			



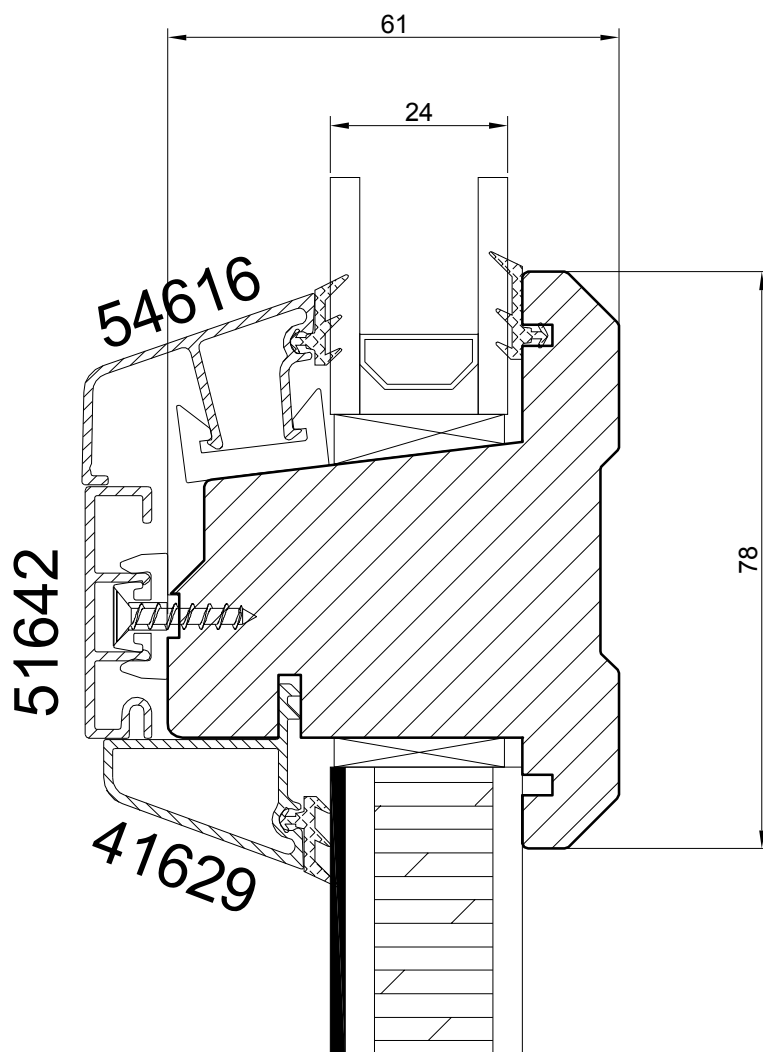

SLIDING DOORS with ALU CLAD

**NORWOOD SP.ZO.O.**

Ul. Rataja 6, Rusocin  
83-031 Łęgowo  
+48 692 22 00  
biuro@norwood.pl

Description

**SDA N95 SLIDING DOORS**

**HORIZONTAL BAR 78 over panel (24 mm glass)**

Revis.	Date	Size	1:1	Drw.	Date	02.01.2018
Verif.	Date	Drawing no.	SDA - 26 - mr - 01			